

TOTO

NEOREST CW996PVD

[EN]

Perform the installation work properly according to this Installation Guide so that the product can function well.





After installation, fully explain how to use it to your customer.





Cautions and warnings (Always observe these warnings.)

Before installation, read these "Cautions and warnings" carefully and attach the equipment correctly. This manual uses various indications to guide safe installation of the product and to prevent injury to customers or other people and damage to property. This product should be installed by a professional. The indications and their meanings are as follows.

Symbol example	Meaning of symbol
 CAUTION	This indicates that misoperation could result in injury or physical damage.

Items to be observed are classified by type and explained with the following pictograms.

	The  symbol indicates something that is prohibited.		The  symbol indicates something that must be done.
--	---	---	---

 CAUTION	
	Do not subject the toilet to strong forces or impacts. Otherwise, the toilet may break causing injury or leaks that may damage property.
	Be sure to use the included or specified parts for installation work. Otherwise, the product may not be installed properly.
	Carry out the installation work according to this installation manual. Otherwise, damage caused by water leaks may occur.

[DE]

Führen Sie die Installationsarbeiten entsprechend dieser Anleitung durch, um sicherzustellen, dass das Produkt richtig funktioniert.
Geben Sie dem Kunden nach der Installation genaue Anweisungen zur Benutzung.

Vorsichtsmaßnahmen und Warnungen





(Beachten Sie diese Warnungen immer.)

Bitte lesen Sie diese "Vorsichtsmaßnahmen und Warnungen" vor der Installation aufmerksam durch und bringen Sie das Produkt entsprechend an. Diese Anleitung enthält zahlreiche Hinweise zur sicheren Installation des Produkts sowie Anmerkungen, wie Sie Verletzungen und Schäden vermeiden können. Das Produkt sollte durch einen professionellen Installateur eingebaut werden. Die Hinweise und ihre Bedeutung sind im Folgenden erklärt.

Symbol-Beispiel	Bedeutung des Symbols
 VORSICHT	Dies weist darauf hin, dass eine falsche Bedienung zu körperlichen Verletzungen oder Sachschäden führen kann.

Zu beachtende Punkte sind nach Typ klassifiziert und anhand der folgenden Piktogramme erläutert.

	Mit  werden verbotene Arbeitsinhalte gekennzeichnet.		Mit  werden unbedingt auszuführende Arbeitsinhalte gekennzeichnet.
--	--	---	---

 VORSICHT	
	Setzen Sie das WC keinen starken Krafteinwirkungen oder Stößen aus. Das WC könnte beschädigt werden und so zu Verletzungen oder zu Sachschäden durch Wasserlecks führen.
	Verwenden Sie für die Installationsarbeiten unbedingt die mitgelieferten bzw. vorgeschriebenen Teile. Anderenfalls besteht die Möglichkeit, dass eine ordnungsgemäße Installation nicht möglich ist.
	Bitte führen Sie die Installationsarbeiten der Anleitung folgend aus. Anderenfalls könnte es zu Wasserlecks kommen.

[FR]

Exécutez correctement l'installation en suivant ces instructions de montage afin de vous assurer que le produit fonctionne convenablement. Une fois l'installation terminée, donnez des instructions précises au client.





Mises en garde et avertissements

(veuillez toujours respecter ces avertissements.)

Avant l'installation, lisez attentivement les "Mises en garde et avertissements" et montez convenablement l'appareil. Ces instructions de montage contiennent diverses indications pour une installation sûre du produit et pour éviter toute blessure et tout dommage. Ce produit doit être installé par un professionnel. Les indications et leurs significations sont expliquées ci-après.

Exemple de symbole	Signification du symbole
 MISE EN GARDE	Ce symbole indique que toute utilisation incorrecte peut entraîner des blessures ou des dommages matériels.

Les articles devant être observés sont classés par type et sont expliqués au moyen des pictogrammes suivants.

	Le symbole  indique quelque chose d'interdit.		Le symbole  indique que quelque chose doit être fait.
---	--	---	--

 MISE EN GARDE	
	Ne soumettez pas le WC à des forces ou à des chocs. Sinon, le WC pourrait être endommagé et entraîner ainsi des blessures ou des dommages matériels dus à des fuites.
	Veillez à bien utiliser les pièces spécifiées ou fournies pour les travaux d'installation. Sinon, le produit peut ne pas être correctement installé.
	Effectuez les travaux d'installation conformément à ces instructions de montage. Sinon, des fuites d'eau peuvent survenir.

[IT]

Eseguire il lavoro di installazione correttamente seguendo questa Guida per l'installazione, in modo che il prodotto possa funzionare bene.
Dopo l'installazione, spiegare completamente al vostro cliente come utilizzarlo.

Precauzioni e avvertenze





(Osservare sempre queste avvertenze.)

Prima dell'installazione, si prega di leggere attentamente queste "Precauzioni e avvertenze" per un montaggio corretto dell'apparecchio. Questo manuale utilizza varie indicazioni per l'installazione sicura del prodotto e per la prevenzione di lesioni fisiche ai consumatori o altre persone, ed anche per danni materiali. Questo prodotto deve essere installato da un installatore professionale. Le indicazioni e i loro significati sono riportati come segue.

Indicazione	Significato del simbolo
 Attenzione	Questo indica che un'operazione errata può avere come conseguenza lesioni o danni fisici.

Le tipologie di voci da osservare sono classificate e spiegate da pittogrammi come viene riportato di seguito.

	 Il simbolo alla sinistra indica qualcosa che è proibito.		 Il simbolo alla sinistra indica qualcosa che deve essere eseguito.
---	--	---	--

 Attenzione	
	Non esercitare una forza eccessiva o urto al Washlet. In caso contrario, il Washlet potrebbe essere rotto provocando lesioni fisiche o perdita di acqua che causa danni materiali.
	Assicurarsi di utilizzare le parti incluse o specificate per il lavoro di installazione. In caso contrario, il prodotto può non essere installato correttamente.
	Eseguire il lavoro di installazione in conformità a questo manuale per l'installazione. In caso contrario, potrebbero verificarsi danni causati da perdite d'acqua.

RU

Выполняйте монтаж надлежащим образом, придерживаясь настоящего руководства, так, чтобы обеспечить хорошую работу прибора. После монтажа подробно разъясните клиенту, как пользоваться прибором.

Предупреждения и уведомления

(Обязательно соблюдайте все предупреждения.)

Перед монтажом внимательно ознакомьтесь с предупреждениями и уведомлениями и подсоедините прибор надлежащим образом. В настоящем руководстве используются различные символы, предназначенные для обеспечения надежного монтажа прибора и предотвращения травм клиента и прочих людей или повреждения имущества. Настоящий прибор может устанавливать только профессионал. Значение указаний и предупреждений:

Пример символа	Значение символа
	Наличие данного предупреждения означает, что неправильная эксплуатация чревата тяжелыми травмами.

Предупреждающие символы разделены на виды и указывают обязательность соблюдения требований.

	Символ указывает на запрещенное действие.		Символ указывает на действие, которое следует обязательно выполнить.
--	--	--	---

Осторожно	
	Не подвергайте унитаз сильным нагрузкам или внезапным ударам. В противном случае унитаз может сломаться и причинить травмы, или привести к утечке воды, которая может повредить имущество.
	Для проведения монтажа обязательно пользуйтесь деталями, прилагаемыми к продукту, или специнструментом. В противном случае вы не сможете установить прибор правильно.
	Устанавливайте прибор, соблюдая руководство по монтажу. В противном случае возможна утечка воды и повреждение имущества.

Included Parts / Mitgelieferte Teile / Pièces fournies / Parti incluse / Комплектующие части

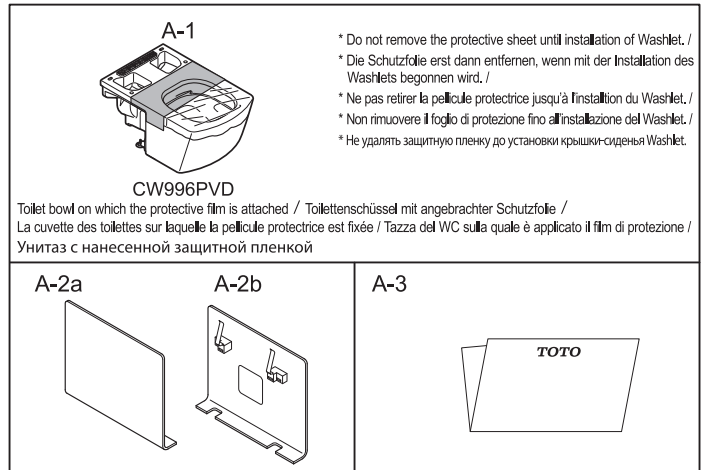

- The product may be slightly different in shape than the product shown in the figure depending on the model. /
- Je nach Modell kann die Form des Produkts leicht von der Abbildung abweichen. /
- Dependendo do modelo, o produto pode ser ligeiramente diferente, com respeito a sua forma, do produto mostrado na figura. /
- A seconda del modello, il prodotto potrebbe avere una forma leggermente differente da quella mostrata nell'illustrazione. /
- В зависимости от артикула данное изделие и схема могут частично отличаться.

Required tools / Erforderliches Werkzeug / Outils requis / Utensili richiesti / Необходимые инструменты

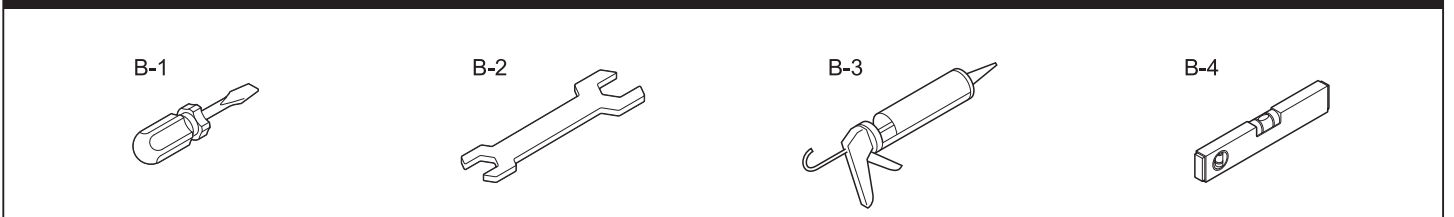

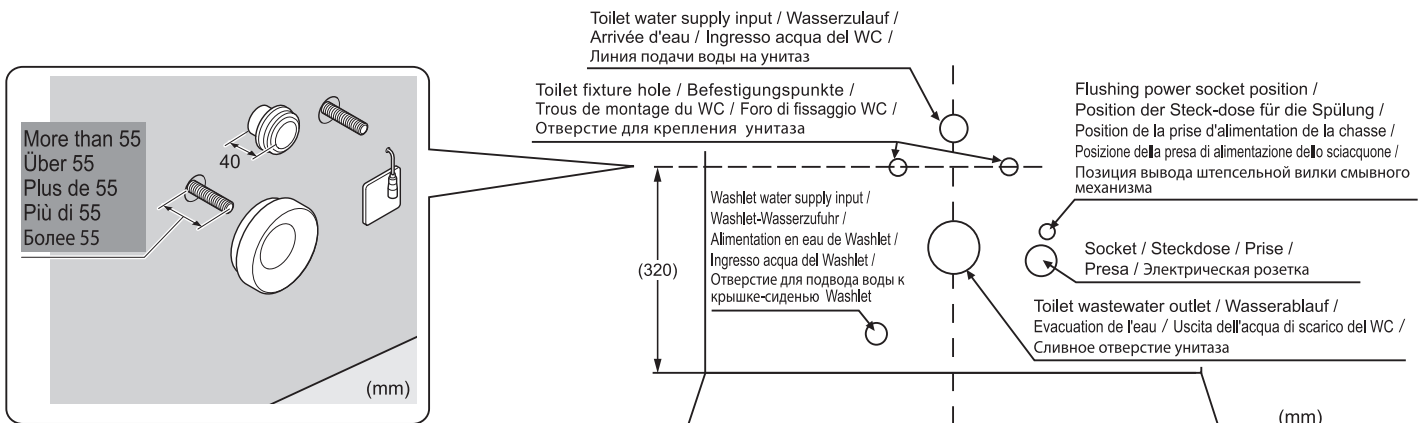

Before Installing / Vor der Installation / Avant l'installation / Prima dell'installazione / Перед установкой

- Make sure that the surface of the bowl doesn't come in contact with silicone.
- Achten Sie darauf, dass die Oberfläche der Toilettenschüssel nicht mit Silikon in Kontakt kommt.
- Assurez vous que la cuvette ne soit pas en contact avec le silicone.
- Fare attenzione a non far aderire il sigillante silicico alla parte interna della tazza del WC.
- Пожалуйста, не допускайте попадание защитной пленки внутрь чаши унитаза.





Meaning of the indications / Bedeutung der Hinweise /
Signification des indications / Significato delle indicazioni /
Значение символов



EN

-  : Task that must be conducted by the installer
-  : Work that requires confirmation
-  : Shows the work sequence



DE

-  : Diese Aufgabe ist vom Installateur auszuführen
-  : Bei dieser Tätigkeit ist eine Bestätigung erforderlich
-  : Zeigt den Arbeitsablauf an



FR

-  : Tâche incombant à l'installateur
-  : Tâche exigeant une vérification
-  : Indique l'ordre de suivi de la procédure

IT

-  : Lavoro che deve essere effettuato dall'installatore
-  : Lavoro che richiede conferma
-  : Mostra la sequenza del lavoro

RU

-  : Работа выполняется специалистом
-  : Требуется подтверждение
-  : Порядок действий

Installing the NEOREST / Installation des NEOREST /
Installation du NEOREST / Installazione del NEOREST /
Процедура установки

1

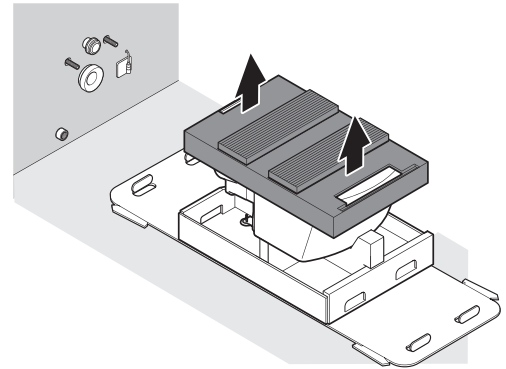

2

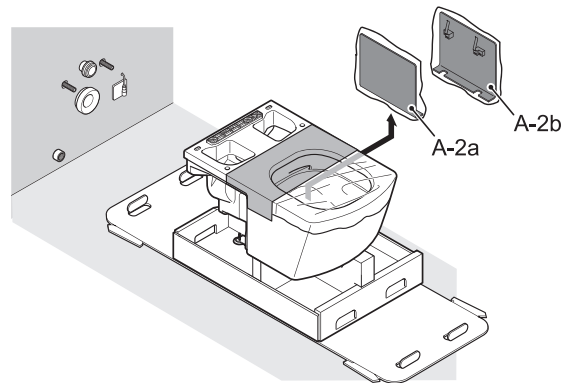

3

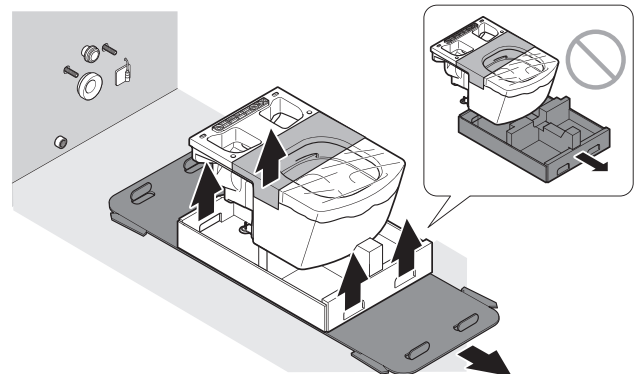

4

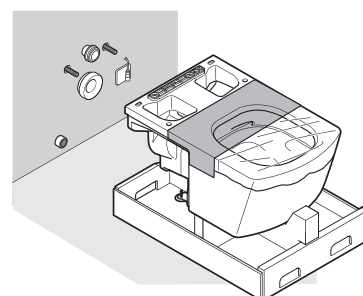

5

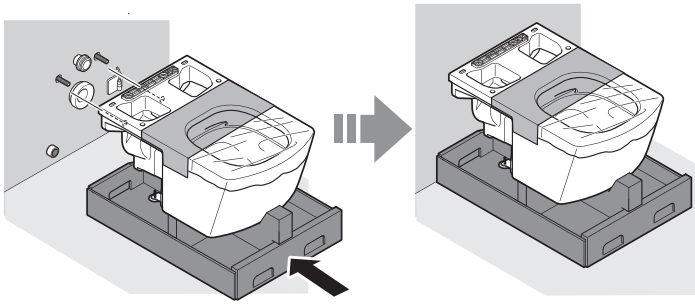

[EN]	⚠ CAUTION
! Required	Connect the main unit securely to the toilet's water supply input and wastewater output. Incomplete connection could cause foul odours or water to leak.
[DE]	⚠ VORSICHT
! Zwingend erforderlich	Verbinden Sie das Hauptgerät sicher mit der Wasserzufuhr und dem Wasserablauf der Toilette. Sind diese Teile nicht richtig miteinander verbunden, kann es zu unangenehmen Gerüchen oder undichten Stellen kommen.
[FR]	⚠ MISE EN GARDE
! Requis	Raccordez convenablement l'unité principale à l'alimentation en eau et à l'évacuation des eaux usées des toilettes. Un mauvais raccordement peut entraîner le dégagement d'odeurs nauséabondes ou une fuite d'eau.
[IT]	⚠ ATTENZIONE
! Obbligatorio	Collegare saldamente l'unità principale all'ingresso acqua del WC e all'uscita dell'acqua di scarico. Se il collegamento non viene eseguito correttamente, si potrebbero sprigionare cattivi odori oppure potrebbero verificarsi casi fuoriuscite d'acqua.
[RU]	⚠ Осторожно
! Обязательно	Надежно подсоедините чашу унитаза к отверстию для подачи воды и отверстию для отработанной воды. Ненадлежащее соединение может привести к тому, что из унитаза будут исходить неприятные запахи или происходить утечка воды.

6

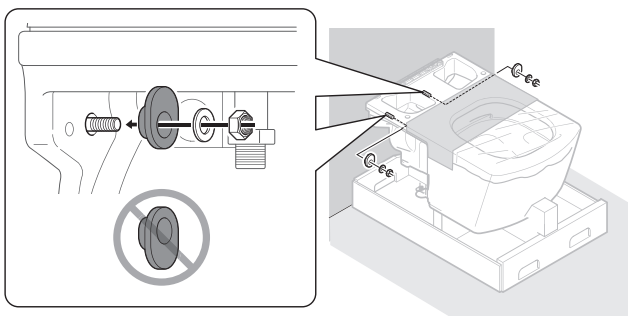

7

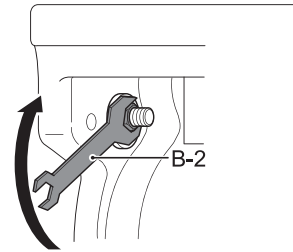

8

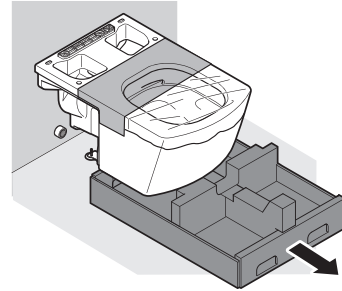

9

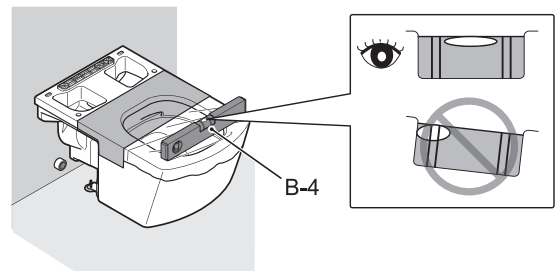

10

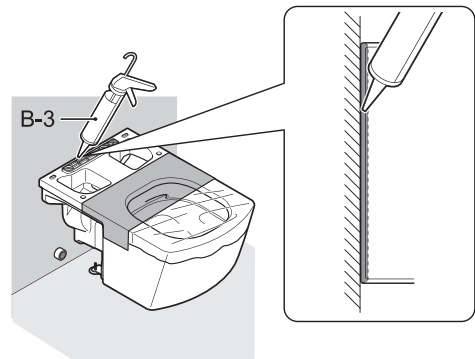

11

Mount the Washlet main unit according to the installation manual included in the package of the Washlet main unit. /
 Installieren Sie das Washlet anhand der Anleitung, die dem Washlet beiliegt. /
 Montez l'unité supérieure conformément au manuel d'installation. /
 Montare l'unità principale del Washlet seguendo il manuale di installazione incluso nella confezione dell'unità principale del Washlet. /
 Установку крышки-сиденья Washlet проводить в соответствии с прилагаемой к ней инструкцией.

12

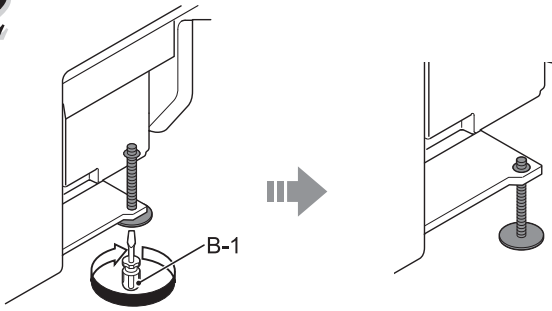

13

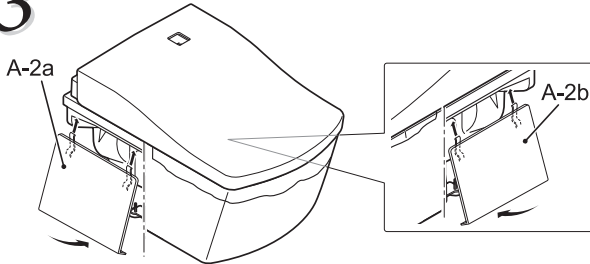

14

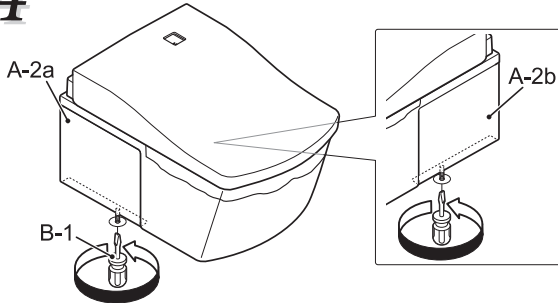

15

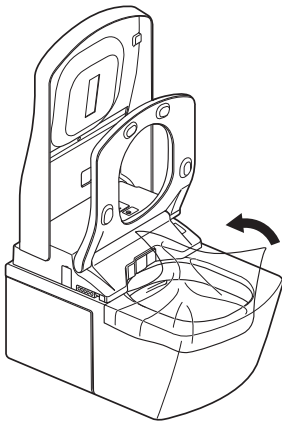

16

- After the trial-run (flush) of the toilet bowl, check the toilet bowl inside for foreign matter such as chips of cut pipe, etc. Foreign matters such as transmitted rust can stick to the sides.
- Make sure that there are no scratches in the gray area of the earthenware. If metallic objects (watchbands, belt buckles, etc.) strongly contacts or scrapes against the surface of earthenware, a black or silver streak may be left. If marked by such a streak, remove it by gently rubbing the surface with an abrasive detergent, etc.
- After installation, unseen dirt (oil or adhesive for piping) may remain in the toilet bowl. Be sure to wipe it off using a non-abrasive neutral detergent for toilets. Otherwise, the toilet bowl surface may not flush completely clean.
- If silicone adhere to the surface of the toilet bowl, please contact TOTO.



- Nach dem Probetrieb (Betätigung der Wasserspülung) der Toilette prüfen Sie das Innere der Toilettenschüssel auf Fremdkörper wie z. B. Rohrschnittabfälle. Fremdkörper wie hereingespülter Rost können sich u. U. an den Seiten festsetzen.
- Die graue Keramikfläche darf keinesfalls verkratzt werden. Falls Metallgegenstände (z. B. Uhrenarmbänder oder Gürtelschnallen) heftig gegen die Keramikoberfläche schlagen oder an ihr entlang kratzen, können schwarze oder silbrige Streifen zurückbleiben. Gegebenenfalls sind solche Streifen durch behutsames Reiben der Oberfläche z. B. mit einem Scheuermittel zu entfernen.
- Nach der Installation verbleiben u. U. nicht sichtbare Verschmutzungen (Öl oder Klebstoff zur Leitungsverlegung) in der Toilettenschüssel. Wischen Sie diese Spuren unbedingt mit einem milden Reinigungsmittel (kein Scheuermittel) für Toiletten ab. Andernfalls wird die Toilettenschüsseloberfläche u. U. nicht vollständig sauber gespült.
- Verbleibt Silikondichtmittel auf der Oberfläche der Toilettenschüssel, wenden Sie sich diesbezüglich an TOTO.

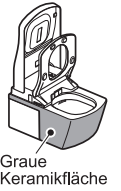

- Après le fonctionnement d'essai (chasse d'eau) de la cuvette des toilettes, vérifiez que l'intérieur de la cuvette des toilettes ne présente pas de corps étrangers tels que copeaux de tuyaux coupés, etc. Tout corps étranger tel qu'un dépôt de rouille peut adhérer aux côtés.
- Assurez-vous que la zone grise de la faïence ne présente pas d'éraflure. Si des objets métalliques (bracelets de montre, boucles de ceinture, etc.) entrent fortement en contact ou raclent la surface de la faïence, cela peut laisser une trainée noire ou argentée. Si la faïence est marquée de telles trainées, retirez-les en frottant doucement la surface avec un détergent abrasif, etc.
- Après l'installation, de la crasse invisible (huile ou adhésif de tuyauterie) peut demeurer dans la cuvette des toilettes. Veillez à bien l'essuyer en utilisant un détergent neutre non abrasif pour toilettes. Sinon, la chasse d'eau peut ne pas complètement nettoyer la surface de la cuvette des toilettes.
- Si des résidus de silicone adhère à la surface de la cuvette des toilettes, merci de contacter TOTO.

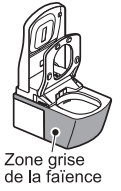

- Dopo la prova di collaudo (lavaggio) della tazza del WC, controllare l'interno della tazza del WC per la presenza di eventuali materiali estranei, come ad esempio residui di tubo tagliato, ecc. I materiali estranei, come ruggine trasmessa possono aderire alle superfici.
- Accertarsi che non ci sia nessun graffio nell'area grigia della ceramica. Se oggetti metallici (cinturini di orologio, fibbie di cinture, ecc.) urtano o graffiano la superficie della ceramica, potrebbe rimanere una rigatura nera o argento. Se rimane traccia di tale rigatura, rimuoverla delicatamente sfregando la superficie con un detergente abrasivo, ecc.
- Dopo l'installazione, potrebbe rimanere dello sporco non visibile (olio o adesivo per tubazioni) nella tazza del WC. Assicurarsi di eliminarlo utilizzando un detergente neutro non abrasivo per toilette. Diversamente, la superficie della tazza del WC potrebbe non essere lavata completamente.
- Se il sigillante siliconico aderisce all'interno della tazza, chiedere a TOTO come rimuoverlo.

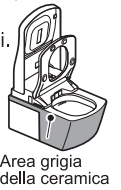

- После пробного смыва убедиться, что на поверхности унитаза нет стружки и пр., оставшейся от нарезания труб. Ржавчина и прочие посторонние предметы могут налипать на поверхность.
- Убедиться в отсутствии царапин и пр. в отмеченной серым цветом части унитаза. При контакте металлических предметов (браслета часов, пряжки ремня и пр.) с поверхностью унитаза на ней могут остаться черные или серые следы. Такие следы удаляются при помощи абразивного чистящего средства.
- По окончании установки на поверхности унитаза могут остаться незаметные следы от смазки, клея для труб и пр. Их необходимо очистить туалетным чистящим средством (неабразивным). Если их не очистить, они приведут к значительному загрязнению унитаза при его использовании.
- Если защитная пленка прилипнет к унитазу, свяжитесь, пожалуйста с TOTO.

